

2mL Aspirating Pipettes

Item# 1834



The Globe Scientific aspirating pipettes are available in 1mL, 2mL, 5mL, 10mL, 25mL and 50mL sizes.

Description

Globe Scientific aspirating pipettes are manufactured under strict ISO 9001:2008 standards in a class 100,000 cleanroom. They are non-pyrogenic, non-cytotoxic, RNase-free and DNase-free. These economical, non-graduated pipettes are an ideal choice where precise measurement of transfer is not required.

Features

- Manufactured under strict ISO 9001:2008 standards
- Produced in a class 100,000 cleanroom
- Non-pyrogenic and non-cytotoxic
- RNase-free and DNase-free
- Sterile pipettes are sterilized by gamma irradiation (SAL 10⁻⁶)
- Individually wrapped in thermoformed paper/plastic peel packaging
- Transparent, no graduations
- Fits all major brands of pipettors
- Safe alternative to glass aspirating pipettes

Products

Item#	Description	Units
1834	2mL, sterile aspirating pipette individually wrapped	1 per pack, 800 per case

Continued . . .

2mL Aspirating Pipettes

Item# 1834

Technical Specifications

- Material: Polystyrene (PS) USP Class 6 approved
- Plug: Non-plugged
- Sterility: Sterilized by gamma irradiation (SAL 10^{-6})
- Length: 275mm (10.83")
- Temperature Range: 0°C to +40°C
- Shelf Life: 3 years after month of production
- Manufactured under ISO 9001:2008 quality standards
- Pyrogen-free, non-cytotoxic
- RNase-free and DNase-free

Data Table

Item	(mL)	Packaging
1834	2mL	Individual Paper/Plastic

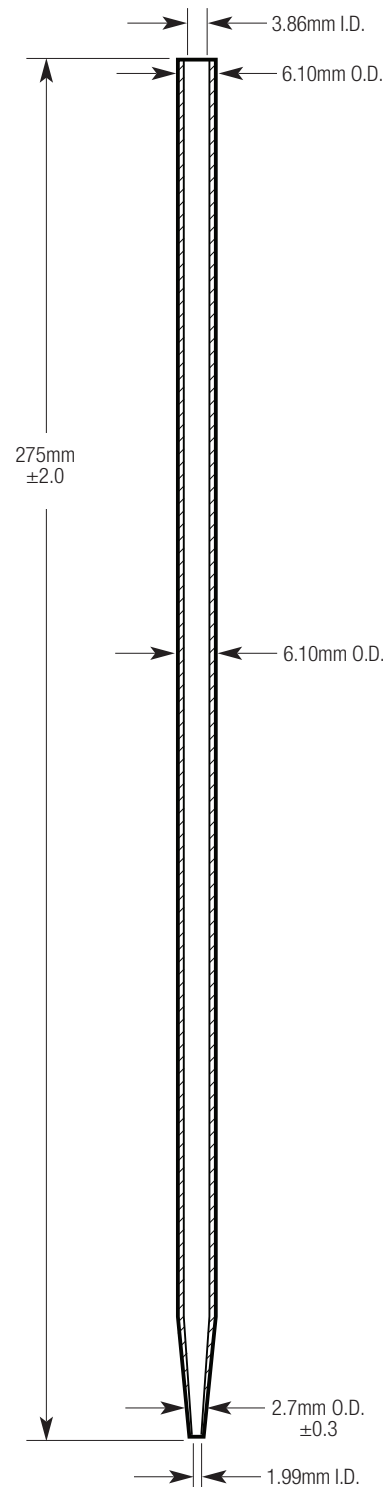

Customer service, sales and technical support:

Phone 1 (800) 394-4562 • 1 (201) 599-1400

Fax 1 (201) 599-1406

E-mail mail@globescientific.com

Globe Scientific Inc.

400 Corporate Drive • Mahwah NJ 07430

www.globescientific.com